

POWER SUPPLIES/FEEDS

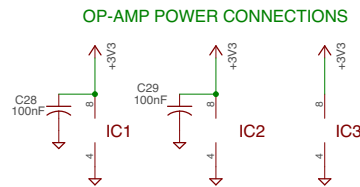

PIN HEADERS

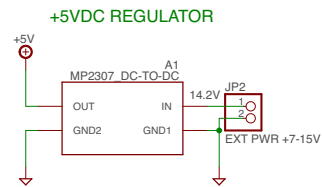
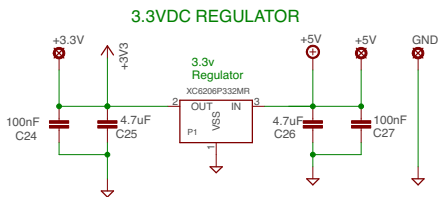
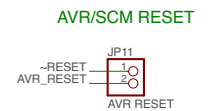
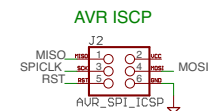
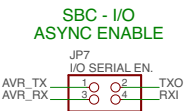
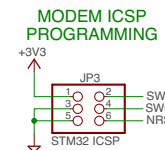
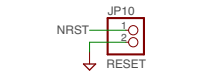
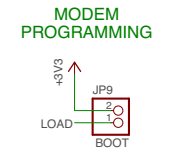
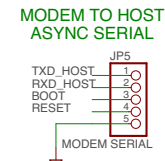
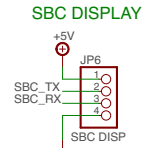
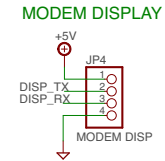

DIGITAL I/O BUFFERS

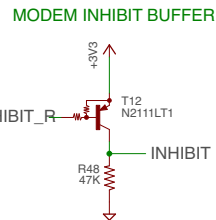
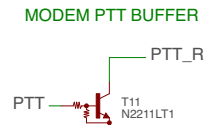
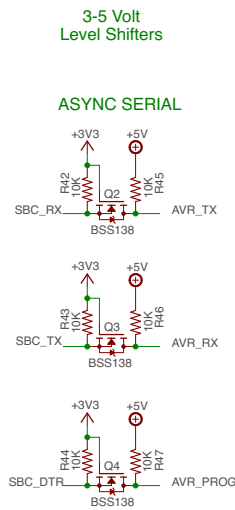
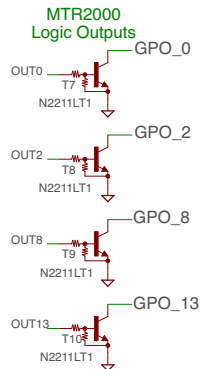
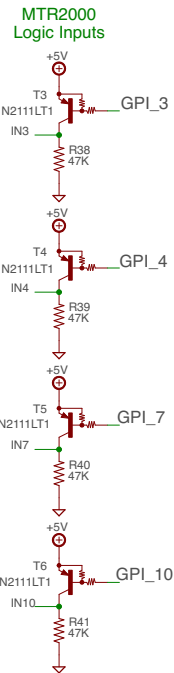

ANALOG CONDITIONING

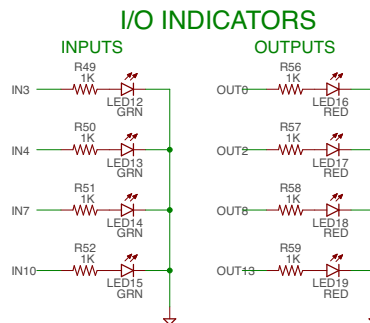
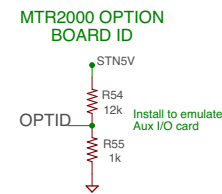
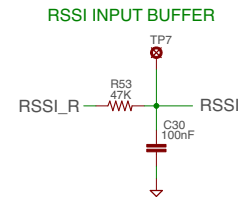

		Courtney T. Buffington N0MJ5	
TITLE: STM32_DVM_MTR2K v2_0c			
Document Number: 20191126			REV: B
Date: 12/5/19 4:01 PM			Sheet: 2/2